

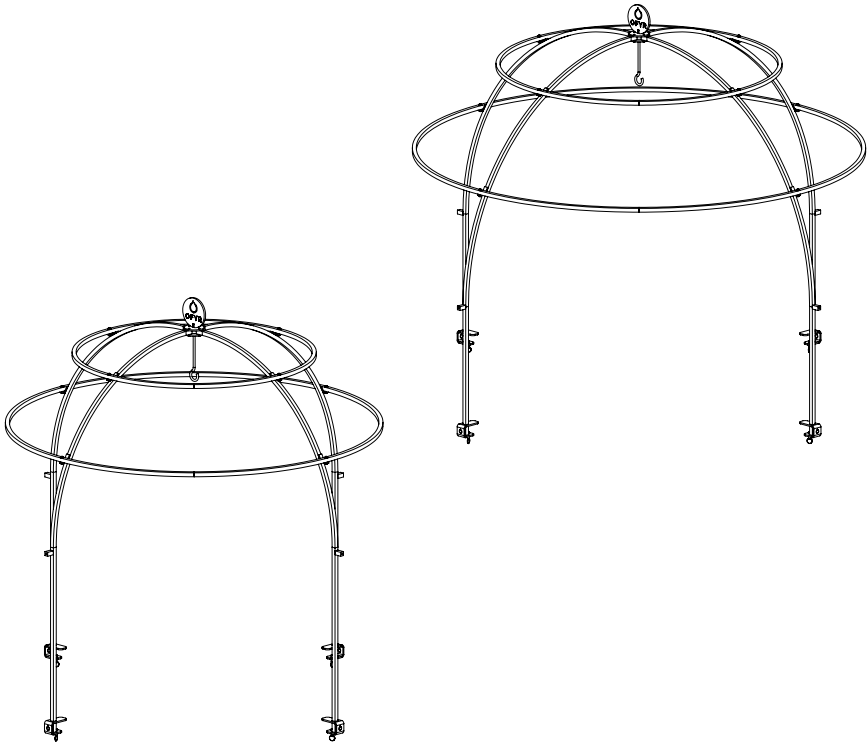

OFYR®

MANUAL



CAGE



EN

Your language can be found from page

4

DE

Ihre Sprache finden Sie ab Seite

10

FR

Trouvez votre langue à partir de la page

16

NL

Uw taal begint op pagina

22



EN Your language not found? Please take a view with this QR-code.

DE Ihre Sprache nicht gefunden? Mit diesem QR-Code erhalten Sie weitere Information.

FR Vous ne trouvez pas la langue qu'il vous faut ? Veuillez utiliser ce code QR.

NL Uw taal niet gevonden? Probeer eens met deze QR-code.



TABLE OF CONTENT

1. INTRODUCTION	5
1.1 OFYR® Cage	5
1.2 Specifications	5
2. SAFETY AND SETUP INSTRUCTIONS	6
3. WARRANTY TERMS PER ELEMENT	7
4. ASSEMBLY INSTRUCTIONS	8
4.1 OFYR® Cage 120	8
4.2 OFYR® Cage XL	9

1. INTRODUCTION

THANK YOU FOR PURCHASING AN OFYR® PRODUCT. THIS MANUAL IS INTENDED FOR YOUR OFYR® CAGE. THIS MANUAL INCLUDES INSTALLATION INSTRUCTIONS, GUARANTEE CONDITIONS AND ADDITIONAL INFORMATION ABOUT YOUR OFYR® CAGE.

1.1 OFYR® CAGE

Outdoor cooking is elevated to a higher level with the OFYR® Cage. This dome-like accessory allows food to be suspended from the steel frame, creating a unique and interactive visual element. The heat from the fire slowly cooks the ingredients, from vegetables and fruits to meats and fish. The cage consists of 4 individual half-arches, which are kept in place with 2 small plates. 2 horizontal rings are placed over the arches, transforming this accessory into a cage, and providing extra stability. The lower ends of the arches are attached to the outer edge of the cooking plate with special wingnuts. The OFYR® Cage is available for the OFYR® Cooking Unit XL, OFYR Trailer and the OFYR® Classic PRO+.

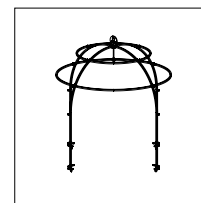

OFYR® CAGE 120

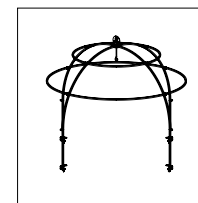

OFYR® CAGE XL

1.2 SPECIFICATIONS

	120	XL
Material	Black steel	Black steel
Dimensions	117x117x119 cm	150x150x119 cm
Weight	13 kg	15.5 kg
Max. load hook	15 kg	15 kg
Max. load cage	40 kg	40 kg













SYMBOLS & ICONS

 **Danger!** Risk of serious or deadly injury or severe product damage.

 **Warning!** Risk of injury or product damage.

 **Notice!** Useful information.

2. SAFETY AND SETUP INSTRUCTIONS

-  Due to the considerable weight of the elements, always unpack and place the OFYR® Cage with at least 2 people.
-  Install the OFYR® Cage on the ground. Place the 4 half-arches in the shape of the cage, then secure them at the top with the 2 plates and bolts. Place the 2 horizontal rings over the frame and secure them with the bolts. Then lift the cage over the cooking plate with 2 people, aligning the legs with the corners of the base. Secure the legs with the wingnuts.
-  Always place the OFYR® Cage on your cooking unit before lighting the fire.
-  The bolts of the OFYR® Cage might loosen due to the heat of the fire. Retighten the bolts while cooking, especially the wingnuts near the cooking plate.
-  Never leave your OFYR® Cage unattended during use.
-  Keep children and pets away from your OFYR® Cooking Unit and OFYR® Cage during and after use, especially when the units and parts are still warm.
-  The OFYR® Cage can get very hot during use. Only move them using heat-resistant gloves like the OFYR® Gloves.
-  When removing the OFYR® Cage while the parts are still hot, make sure to only place them on a heatproof surface.
-  The various parts of the OFYR® Cage will most likely be greasy after use. When the greasy parts are placed on stone and wooden surfaces, they will likely leave permanent stains.
-  After use, the various parts should be cleaned and oiled.
-  Store the OFYR® Cage in a dry place with low humidity to avoid corrosion.
-  Always remove the OFYR® Cage from the OFYR® Trailer before driving.

3. WARRANTY TERMS PER ELEMENT

A limited lifetime guarantee applies to the materials and construction of all parts of the OFYR® Cage for the original buyers or owners, provided that they purchased their product from an authorised dealer and registered their warranty in the required manner through the OFYR Club at www.ofyr.club.

	B2B	B2C
Black steel	2 years	1 year

This warranty covers manufacturing defects. It applies to the original buyers or owners of an OFYR® Cage provided that:

- They purchased their product from an authorised dealer.
- They assembled, used and maintained the OFYR® Cage according to the instructions in this manual.

NOT COVERED BY WARRANTY

- Wear, corrosion, deformation and discolouration of parts exposed to fire.
- Corrosion and discolouration caused by external influences.
- Visual irregularities inherent to the manufacturing process.
- Damages caused by not following our instructions and tips for safety, setup, intended use and maintenance.

4. ASSEMBLY INSTRUCTIONS

4.1 OFYR® CAGE 120

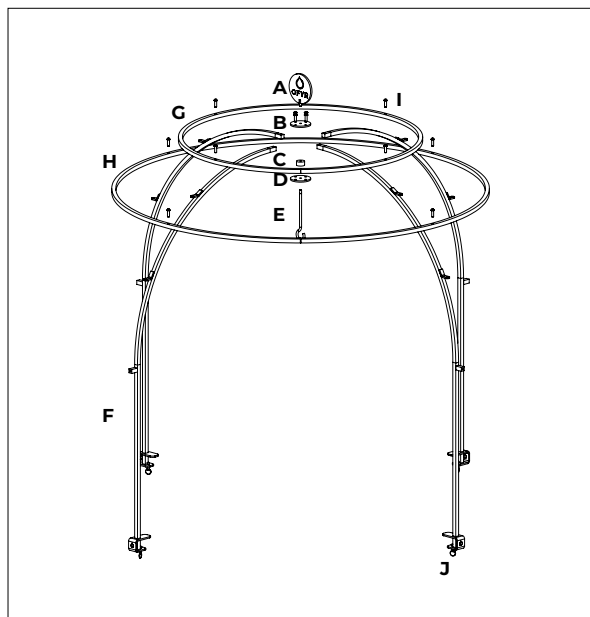

PARTS LIST

- A. OFYR Logo
- B. Round connection plate
- C. Round intermediate ring
- D. Round connection plate with thread
- E. Hook
- F. Arches
- G. Small ring
- H. Large ring

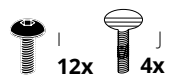

4.2 OFYR® CAGE XL

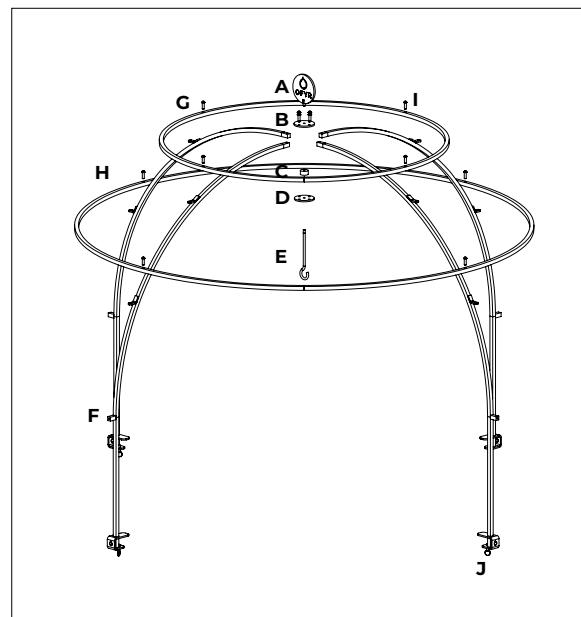

PARTS LIST

- A. OFYR Logo
- B. Round connection plate
- C. Round intermediate ring
- D. Round connection plate with thread
- E. Hook
- F. Arches
- G. Small ring
- H. Large ring

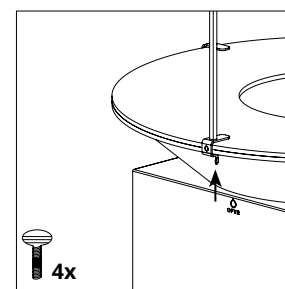
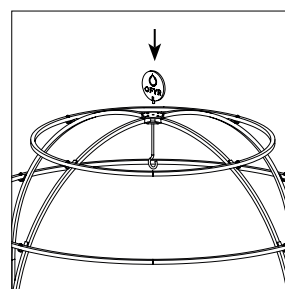
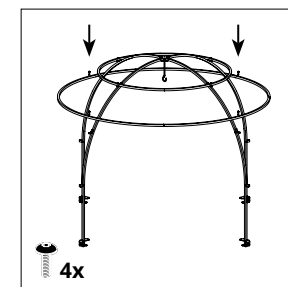
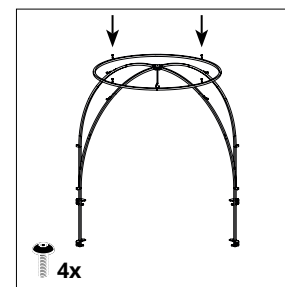
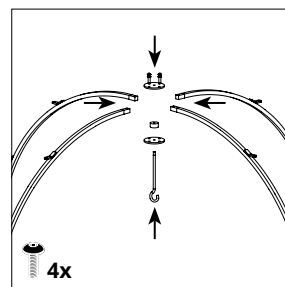
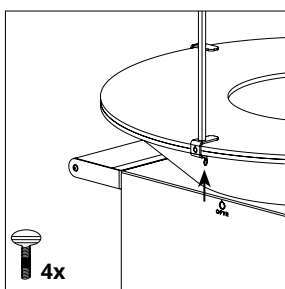
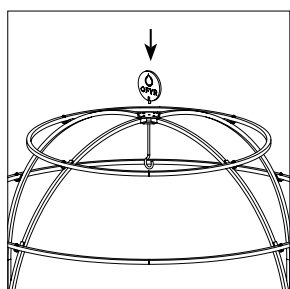
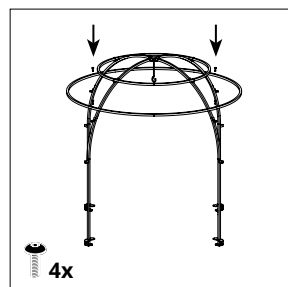
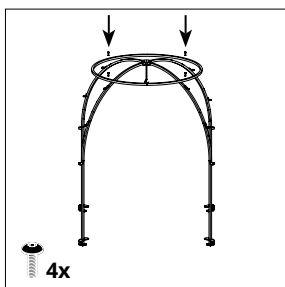
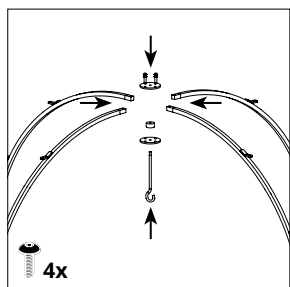

INHALTSVERZEICHNIS

1. EINLEITUNG	11
1.1 OFYR® Cage	11
1.2 Spezifikationen	11
2. SICHERHEITS- UND AUFBAUHINWEISE	12
3. GARANTIEBEDINGUNGEN PRO ELEMENT	13
4. MONTAGEANLEITUNGEN	14
4.1 OFYR® Cage 120	14
4.2 OFYR® Cage XL	15

SYMBOLS UND IKONEN

 **Gefahr!** Gefahr von schweren oder tödlichen Verletzungen oder schweren Produktschäden.

 **Warnung!** Verletzungsgefahr oder Produktschäden.

 **Zum Beachten!** Nützliche Informationen.

1. EINLEITUNG

VIELEN DANK, DASS SIE EIN OFYR® PRODUKT GEKAUFT HABEN. DIESES HANDBUCH ENTHÄLT ANWEISUNGEN ZUR EINRICHTUNG, GARANTIEBEDINGUNGEN UND ZUSÄTZLICHE INFORMATIONEN ÜBER IHR OFYR® CAGE.

1.1 OFYR® CAGE

Mit dem OFYR® Cage wird das Kochen im Freien auf ein höheres Niveau gehoben. Durch seine kuppelförmige Konstruktion können die Speisen an den Stahlrahmen aufgehängt werden, dadurch entsteht ein einzigartiges und interaktives visuelles Element. Die Zutaten garen langsam in der Hitze des Feuers: Fleisch, Fisch, Obst und Gemüse. Der Cage besteht aus 4 einzelnen Halbbögen, die mit 2 kleinen Platten an der Oberseite in Position gehalten werden. Über den Bögen sind 2 Horizontale angebracht, die dieses Zubehör in einen Käfig verwandeln und für zusätzliche Stabilität sorgen. Die unteren Enden der Bögen werden mit speziellen Flügelmuttern am äußeren Rand der Kochplatte befestigt. Der OFYR® Cage ist für das OFYR® XL, OFYR Trailer und das OFYR® Classic PRO+ erhältlich.

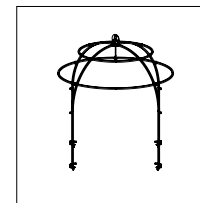

OFYR® CAGE 120

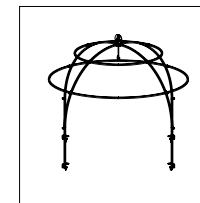

OFYR® CAGE XL

1.2 SPEZIFIKATIONEN

	120	XL
Material	Schwarzer Stahl	Schwarzer Stahl
Abmessungen	117x117x119 cm	150x150x119 cm
Gewicht	13 kg	15,5 kg
Maximale Hakenlast	15 kg	15 kg
Maximaler Last Cage	40 kg	40 kg

2. SICHERHEITS- UND AUFBAUHINWEISE

-  Aufgrund des beträchtlichen Gewichts der Einzelteile sollte das Auspacken, Aufbauen und Platzieren des Produkts von mindestens 2 Personen vorgenommen werden.
-  Den OFYR® Cage auf dem Boden montieren. Legen Sie die 4 Bögen in die Form des Käfigs und befestigen Sie sie oben mit den 2 Platten und Schrauben. Legen Sie die 2 horizontalen Ringe über die Bögen und befestigen Sie sie mit den Bolzen. Dann heben Sie den Cage mit 2 Personen über die Kochplatte, wobei Sie die Beine an den Ecken der Basis ausrichten. Sichern Sie die Beine mit den Flügelmuttern.
-  Den OFYR® Cage immer vor dem Anzünden des Feuers auf das Kocheinheit stellen.
-  Die Schrauben des OFYR® Cage können sich durch die Hitze des Feuers lockern. Ziehen Sie die Bolzen während des Kochens nach, insbesondere die Flügelmuttern in der Nähe der Kochplatte.
-  Lassen Sie Ihren OFYR® Cage während des Gebrauchs niemals unbeaufsichtigt.
-  Halten Sie Kinder und Haustiere vom OFYR® Cage während des Gebrauchs fern sowie nach dem Gebrauch, wenn das Gerät noch warm ist.
-  Die verschiedenen Teile können beim Gebrauch sehr heiß werden. Bewegen Sie sie nur mit hitzebeständigen Handschuhen wie den originalen OFYR® Handschuhen.
-  Beim Herausnehmen der heißen OFYR® Cage aus der OFYR® Kocheinheit, stellen Sie sie nur auf eine hitzebeständige Oberfläche.
-  Die gebrauchten Teile werden höchstwahrscheinlich fettig sein, und wenn man sie auf Stein- und Holzoberflächen legt, werden diese Oberflächen dauerhaft verschmutzt.
-  Nach dem Gebrauch sollten die Teile gereinigt und die Stahlteile geölt werden.
-  Die verschiedenen Zubehörteile sollten an einem trockenen Ort mit geringer Luftfeuchtigkeit gelagert werden, um Korrosion zu vermeiden.
-  Nehmen Sie den OFYR® Cage immer vom OFYR® Trailer ab, bevor Sie fahren.

3. GARANTIEBEDINGUNGEN PRO ELEMENT

Eine beschränkte lebenslange Garantie gilt für das Material und die Konstruktion der OFYR® Cage für die ursprünglichen Käufer oder Besitzer, vorausgesetzt, dass sie ihr Produkt von einem autorisierten Händler gekauft und ihre Garantie in der erforderlichen Weise über den OFYR Club unter www.ofyr.club registriert haben.

	B2B	B2C
Schwarzer Stahl	2 Jahre	1 Jahre

Diese Garantie deckt Herstellungsfehler ab. Sie gilt für die ursprünglichen Käufer oder Besitzer eines OFYR® Cage vorausgesetzt, dass:

- Sie haben ihr Produkt bei einem autorisierten Händler gekauft.
- Sie haben den OFYR® Cage gemäß den Anweisungen in diesem Handbuch zusammengebaut, verwendet und gewartet.

NICHT DURCH GARANTIE ABGEDECKT

- Abnutzung, Korrosion, Verformung und Verfärbung von Teilen, die dem Feuer ausgesetzt sind;
- Korrosion und Verfärbung durch äußere Einflüsse;
- Dem Herstellungsprozess inhärente visuelle Unregelmäßigkeiten;
- Schäden, die durch die Nichtbeachtung unserer Sicherheits- und Aufstellungs-, bestimmungsgemäßen Verwendungs- und Wartungsanweisungen/Tipps entstehen.

4. MONTAGEANLEITUNGEN

4.1 OFYR® CAGE 120

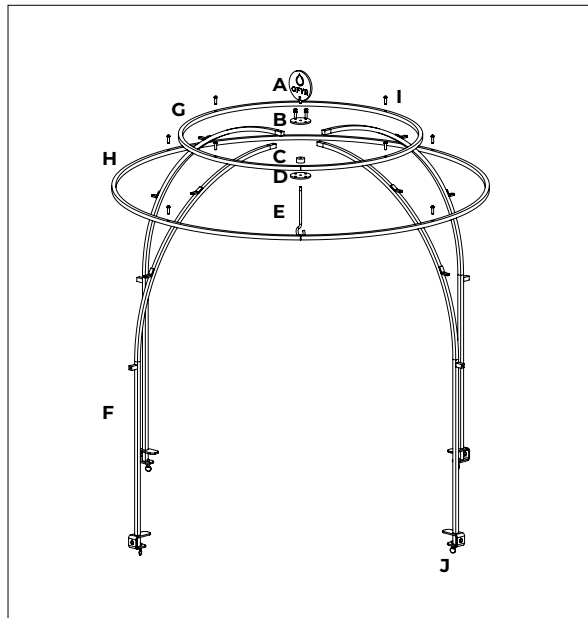

TEILELISTE

- A. OFYR Logo
- B. Runde Anschlussplatte
- C. Runder Zwischenring
- D. Runde Verbindungsplatte mit Gewinde
- E. Haken
- F. Bögen
- G. Kleiner Ring
- H. Großer Ring

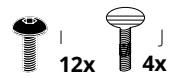

4.2 OFYR® CAGE XL

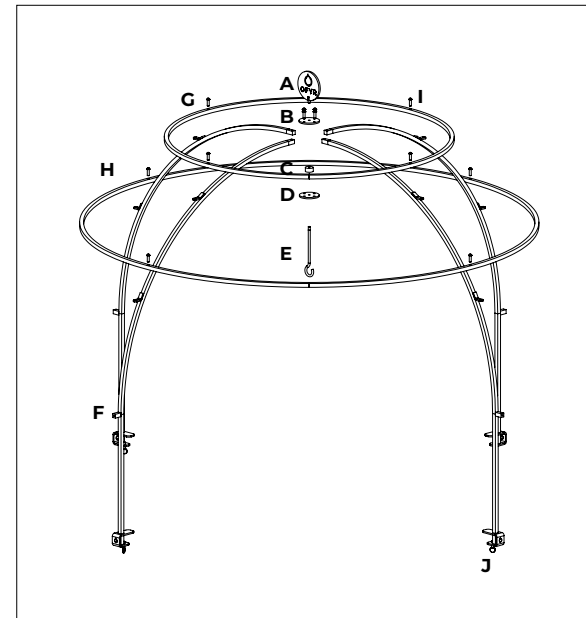

TEILELISTE

- A. OFYR Logo
- B. Runde Anschlussplatte
- C. Runder Zwischenring
- D. Runde Verbindungsplatte mit Gewinde
- E. Haken
- F. Bögen
- G. Kleiner Ring
- H. Großer Ring

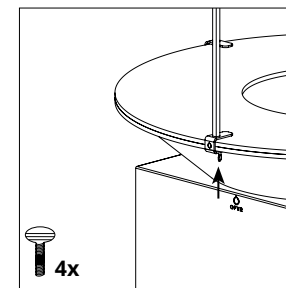
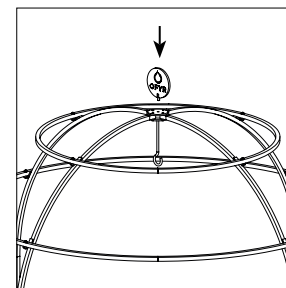
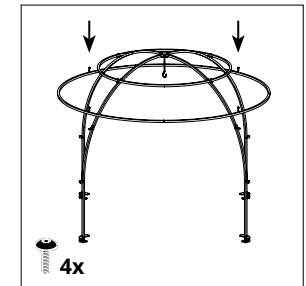
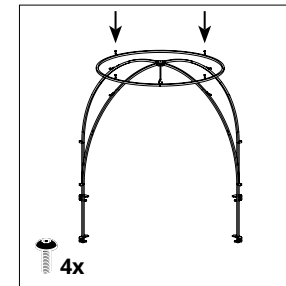
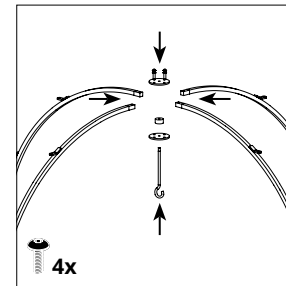
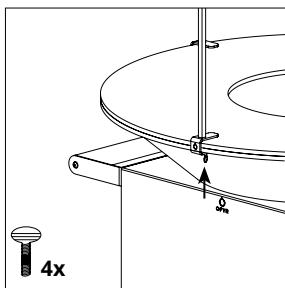
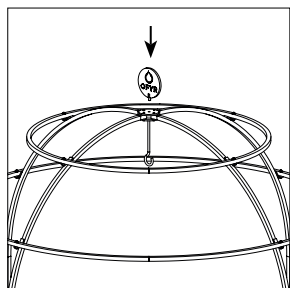
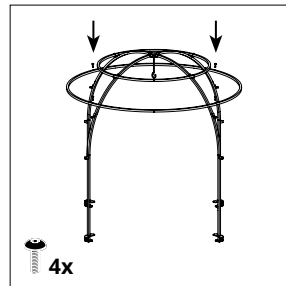
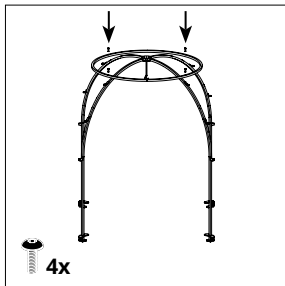
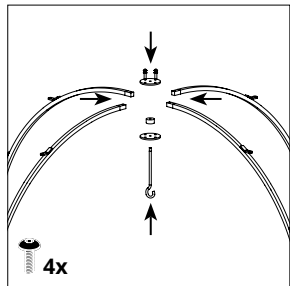

SOMMAIRE

1. INTRODUCTION	17
1.1 OFYR® Cage	17
1.2 Spécifications	17
2. INSTRUCTIONS DE SÉCURITÉ ET D'INSTALLATION	18
3. CONDITIONS DE GARANTIE PAR ÉLÉMENT	19
4. INSTRUCTIONS DE MONTAGE	20
4.1 OFYR® Cage 120	20
4.2 OFYR® Cage XL	21

SYMBOLES ET ICÔNES

 **Danger !** Risque de blessures graves ou mortelles, ou d'endommagement sévère du produit.

 **Avertissement !** Risque de blessures ou d'endommagement du produit.

 **Avis !** Informations utiles.

1. INTRODUCTION

NOUS VOUS REMERCIONS D'AVOIR ACHETÉ UN PRODUIT OFYR®. CE MANUEL CONTIENT LES INSTRUCTIONS D'INSTALLATION, LES CONDITIONS DE GARANTIE AINSI QUE DES INFORMATIONS SUPPLÉMENTAIRES SUR VOTRE OFYR® CAGE.

1.1 OFYR® CAGE

La cuisson en plein air passe à un niveau supérieur avec la Cage OFYR®. Sa structure en forme de dôme permet de suspendre des aliments au cadre en acier, créant ainsi un élément visuel original et utile. La chaleur du feu cuit lentement les aliments, que ce soit de la viande, du poisson, des fruits ou des légumes. La cage se compose de quatre demi-arches individuelles, maintenues en place par deux petites plaques. Deux anneaux horizontaux sont placés sur les demi-arches, transformant cet accessoire en cage et lui conférant une stabilité supplémentaire. Les extrémités inférieures des poutres sont fixées au bord extérieur de la plaque de cuisson à l'aide des écrous à ailettes. La cage OFYR® est disponible pour l'unité de cuisson OFYR® XL, OFYR Trailer et l'OFYR® Classic PRO+.

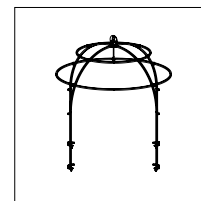

OFYR® CAGE 120

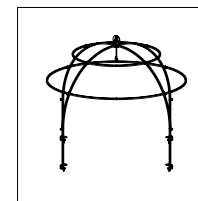











OFYR® CAGE XL

1.2 SPÉCIFICATIONS

	120	XL
Matériau	Acier noir	Acier noir
Dimensions	117x117x119 cm	150x150x119 cm
Poids	13 kg	15,5 kg
Charge maximale du crochet	15 kg	15 kg
Charge maximale de la cage	40 kg	40 kg

2. INSTRUCTIONS DE SÉCURITÉ ET D'INSTALLATION

-  Placez toujours la cage OFYR® sur votre unité de cuisson avant d'allumer le feu.
-  Installez la Cage OFYR® sur le sol. Placez les 4 demi-arches dans la forme de la cage, puis fixez-les en haut avec les 2 plaques et les boulons. Placez les 2 anneaux horizontaux sur les arches et fixez-les avec les boulons. Soulevez ensuite la cage sur la plaque de cuisson avec 2 personnes, en alignant les pieds avec les coins de la base. Fixez les pieds avec les écrous à ailettes.
-  En raison du poids considérable des éléments, le déballage et l'installation produit doit être effectué par au moins 2 personnes.
-  Les boulons de la cage OFYR® peuvent se desserrer sous l'effet de la chaleur du feu. Resserrez les boulons pendant la cuisson, en particulier les écrous à ailettes situés près de la plaque de cuisson.
-  Ne laissez jamais votre cage OFYR® sans surveillance pendant l'utilisation.
-  Tenez les enfants et les animaux domestiques éloignés de la cage OFYR® pendant l'utilisation et après usage lorsqu'elle est encore chaude.
-  Les différentes parties de la cage OFYR® peuvent devenir très chaudes pendant l'utilisation. Ne déplacez ces pièces qu'avec l'aide de gants résistants à la chaleur tels que des gants OFYR®.
-  Lorsque vous retirez les différentes parties de cage OFYR®, placez-les sur une surface résistante à la chaleur.
-  Après utilisation, les différentes parties sont susceptibles d'être grasses. Les placer sur une surface en pierre ou en bois est susceptible de provoquer des taches irréversibles.
-  Après utilisation, les différentes parties doivent être nettoyées et huilées.
-  Les différentes parties de la cage OFYR® doivent être stockées dans un endroit sec, faible en humidité afin d'éviter la corrosion.
-  Retirez toujours la cage OFYR® de la Trailer OFYR® avant de conduire.

3. CONDITIONS DE GARANTIE PAR ÉLÉMENT

Une garantie limitée dans le temps s'applique au matériel et à la construction de toutes les parties de la cage OFYR® pour les acheteurs ou les propriétaires d'origine. Ils doivent avoir acheté leur unité auprès d'un revendeur agréé et enregistré leur garantie de la manière requise via le Club OFYR à l'adresse www.ofyr.club.

	B2B	B2C
Acier noir	2 ans	1 an

Cette garantie couvre les défauts de fabrication. Elle s'applique aux acheteurs ou aux propriétaires d'origine de la cage OFYR® à condition que :

- Ils aient acheté le produit auprès d'un revendeur agréé ;
- Ils aient assemblé, utilisé et entretenu leur cage OFYR® conformément aux instructions reprises dans ce manuel.

NE SONT PAS COUVERTS PAR LA GARANTIE

- Usure, corrosion, déformation et décoloration des parties exposées au feu ;
- Corrosion et décoloration causées par des facteurs externes ;
- Irrégularités visuelles inhérentes au processus de fabrication ;
- Dommages causés par le non-respect de nos conseils/instructions en matière de sécurité, d'installation, d'utilisation et d'entretien.

4. INSTRUCTIONS DE MONTAGE

4.1 OFYR® CAGE 120

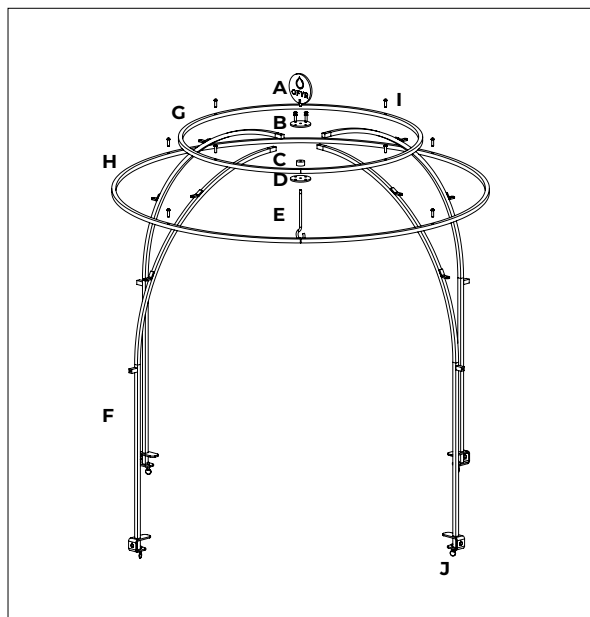

- LISTE DES PIÈCES**
- A. OFYR Logo
 - B. Plaque de connexion ronde
 - C. Anneau intermédiaire
 - D. Plaque de connexion ronde avec filetage de vis
 - E. Crochet
 - F. Arches
 - G. Petit anneau
 - H. Grand anneau

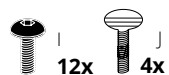

4.2 OFYR® CAGE XL

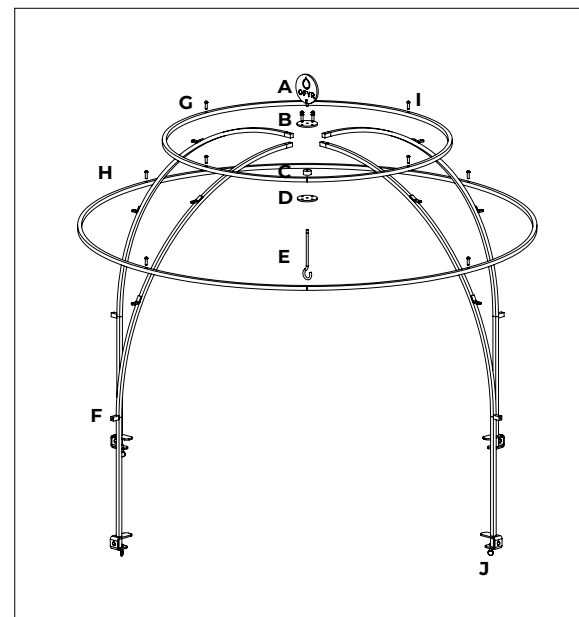

- LISTE DES PIÈCES**
- A. OFYR Logo
 - B. Plaque de connexion ronde
 - C. Anneau intermédiaire
 - D. Plaque de connexion ronde avec filetage de vis
 - E. Crochet
 - F. Arches
 - G. Petit anneau
 - H. Grand anneau

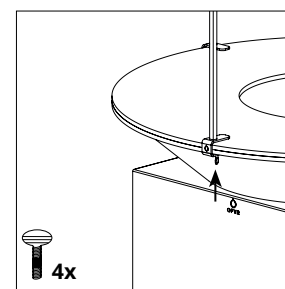
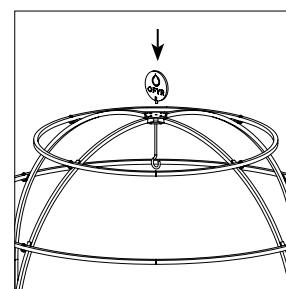
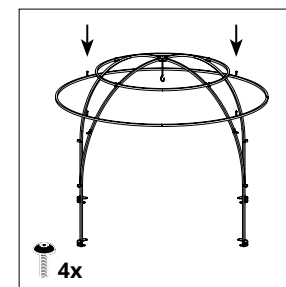
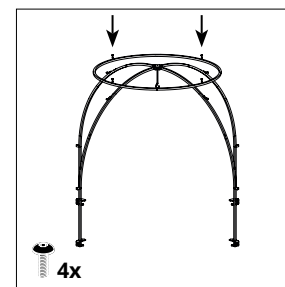
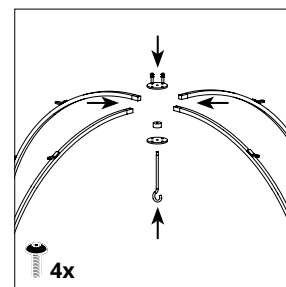
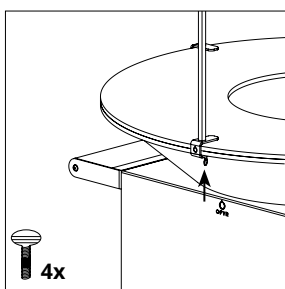
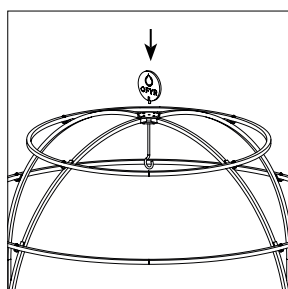
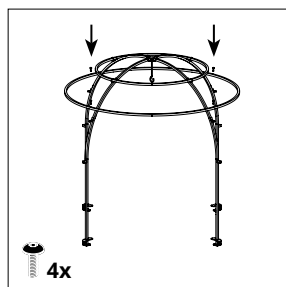
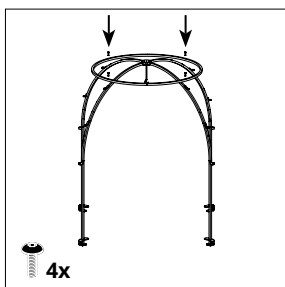
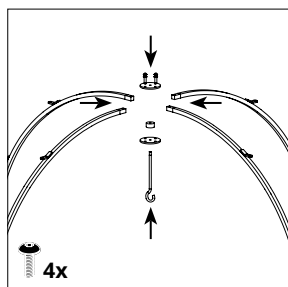

INHOUDSOPGAVE

1. INLEIDING	23
1.1 OFYR® Cage	23
1.2 Specificaties	23
2. VEILIGHEIDS- EN INSTALLATIEVOORSCHRIFTEN	24
3. GARANTIE VOORWAARDEN PER ONDERDEEL	25
4. MONTAGE INSTRUCTIES	26
4.1 OFYR® Cage 120	26
4.2 OFYR® Cage XL	27

1. INLEIDING

BEDANKT VOOR DE AANKOOP VAN EEN OFYR® PRODUCT. DEZE HANDLEIDING BEVAT DE INSTALLATIE INSTRUCTIES, DE GARANTIEVOORWAARDEN EN BIJKOMENDE INFORMATIE OVER UW OFYR® CAGE.

1.1 OFYR® CAGE

Buiten koken wordt naar een hoger niveau getild met de OFYR® Cage. Dit koepelvormige accessoire maakt het mogelijk op voedsel aan de stalen ringen te hangen, waardoor een uniek en interactief visueel element ontstaat. De hitte van het vuur gaart de ingrediënten langzaam, van groenten en fruit tot vlees en vis. De Cage bestaat uit 4 afzonderlijke, halve bogen van staal, die op hun plaats worden gehouden met 2 plaatjes aan de bovenkant. Hierover worden de 2 horizontale ringen geplaatst, die voor extra stabiliteit zorgen en het geheel de uitstraling van een kooi geeft. De bogen worden aan de onderkant aan de buitenrand van de kookplaat bevestigd met vleugelbouten. De OFYR® Cage is verkrijgbaar voor de OFYR® XL, OFYR Trailer en de OFYR® Classic 120 PRO+.

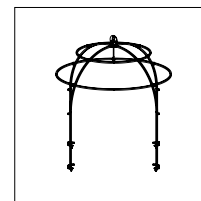

OFYR® CAGE 120

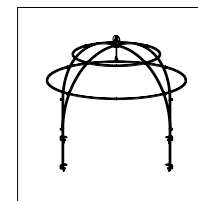

OFYR® CAGE XL

1.2 SPECIFICATIES

	120	XL
Materiaal	Zwart Staal	Zwart Staal
Afmeting	117x117x119 cm	150x150x119 cm
Gewicht	13 kg	15,5 kg
Max. belasting haak	15 kg	15 kg
Max. belasting cage	40 kg	40 kg

SYMBOLLEN EN PICTOGRAMMEN

 **Gevaar!** Risico op ernstig of dodelijk letsel of ernstige schade aan het product.

 **Waarschuwing!** Risico op letsel of schade aan het product.

 **Opmerking!** Nuttige informatie.



2. VEILIGHEIDS- EN INSTALLATIEVOORSCHRIFTEN

-  Gezien het aanzienlijke gewicht van de onderdelen, dient het uitpakken en de installatie van het product door ten minste 2 personen te gebeuren.
-  Monteer de OFYR® Cage op de grond. Zet de 4 halve bogen in de vorm van de kooi en maak ze dan bovenaan vast met de 2 plaatjes. Draai de bouten goed vast. Plaats hier vervolgens de 2 horizontale ringen overheen en maak deze vast met de bouten. Til de kooi daarna met 2 personen over de kookplaat, waarbij de poten uitlijnen met de hoeken van het kooktoestel. Maken de poten goed vast met de vleugelbouten.
-  Plaats de OFYR® Cage op het kooktoestel voordat het vuur wordt aangestoken.
-  De bouten van de OFYR® Cage kunnen door de hitte van het vuur losser gaan zitten. Draai de bouten daarom tijdens het koken opnieuw aan, vooral de vleugelmoeren bij de kookplaat.
-  Laat uw OFYR® Cage tijdens gebruik nooit onbeheerd achter.
-  Houd kinderen en huisdieren uit de buurt van de OFYR® Cage tijdens gebruik en na gebruik wanneer het toestel nog warm is.
-  De diverse onderdelen van de OFYR® Cage kunnen zeer warm worden tijdens het gebruik. Verplaats deze onderdelen uitsluitend met hittebestendige handschoenen zoals de OFYR® Handschoenen.
-  Als u de hete onderdelen van de OFYR® Cage van uw kooktoestel afhaalt, plaats deze dan op een hittebestendige ondergrond.
-  De onderdelen van de OFYR® Cage zullen na gebruik vermoedelijk vet zijn. Als u deze op een stenen of houten ondergrond plaatst, zullen er vermoedelijk niet-verwijderbare vlekken ontstaan.
-  Na gebruik moeten de verschillende onderdelen gereinigd en geolied worden.
-  Bewaar de OFYR® Cage in een droge ruimte met een laag vochtigheidsgehalte om roestvorming te vermijden.
-  Verwijder de OFYR® Cage altijd van de OFYR® Trailer voordat u gaat rijden.

3. GARANTIEVOORWAARDEN PER ONDERDEEL

Er geldt een beperkte tijdsgebonden garantie op het materiaal en de constructie van alle onderdelen van de OFYR® Cage voor de oorspronkelijke kopers of eigenaars, op voorwaarde dat ze hun product bij een erkende dealer hebben gekocht en hun garantie op de vereiste manier hebben geregistreerd via de OFYR Club op www.ofyr.club.

	B2B	B2C
Zwart staal	2 jaar	1 jaar

Deze garantie dekt fabricagefouten. Ze is van toepassing op de oorspronkelijke kopers of eigenaars van een OFYR® Cage, op voorwaarde dat:

- Ze hun product bij een erkende dealer hebben gekocht.
- Ze de OFYR® Cage hebben gemonteerd, gebruikt en onderhouden volgens de instructies in deze handleiding.

NIET GEDEKT DOOR GARANTIE

- Slijtage, corrosie, vervorming en verkleuring van aan vuur blootgestelde onderdelen.
- Corrosie en verkleuring veroorzaakt door invloeden van buitenaf.
- Zichtbare onregelmatigheden als gevolg van het productproces.
- Schade die is veroorzaakt door het niet opvolgen van onze veiligheids-, installatie-, gebruiks- en onderhoudsinstructies/tips.

4. MONTAGE INSTRUCTIES

4.1 OFYR® CAGE 120

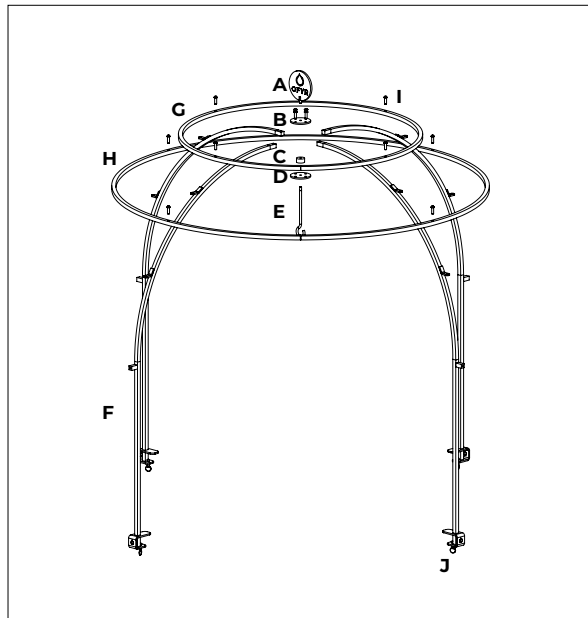

ONDERDELENLIJST

- A. OFYR Logo
- B. Ronde koppelplaat
- C. Ronde tussenring
- D. Ronde koppelplaat met schroefdraad
- E. Haak
- F. Bogen
- G. Kleine ring
- H. Grote ring



4.2 OFYR® CAGE XL

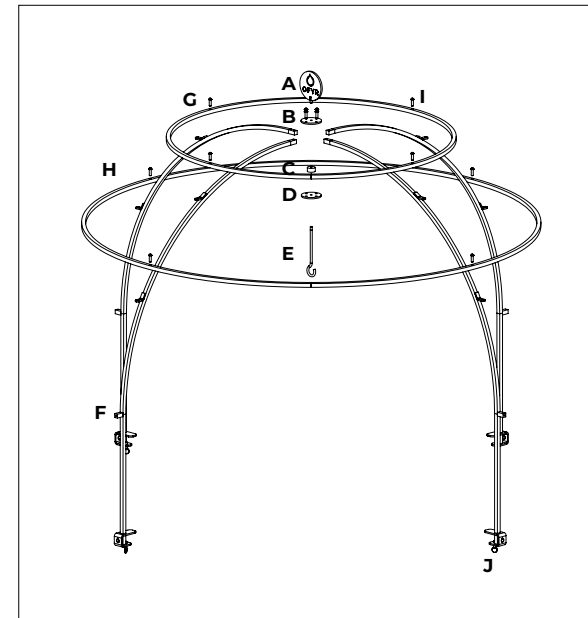

ONDERDELENLIJST

- A. OFYR Logo
- B. Ronde koppelplaat
- C. Ronde tussenring
- D. Ronde koppelplaat met schroefdraad
- E. Haak
- F. Bogen
- G. Kleine ring
- H. Grote ring

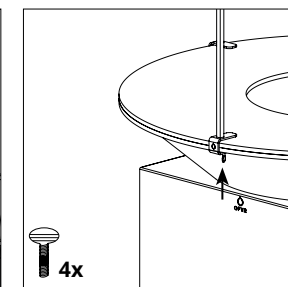
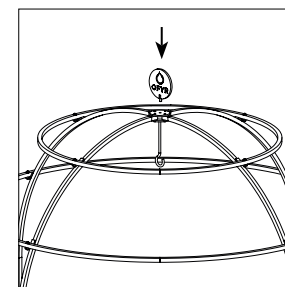
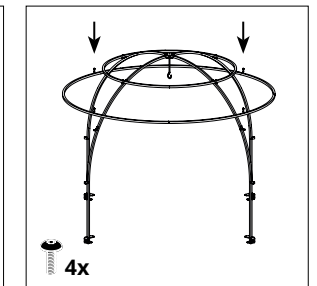
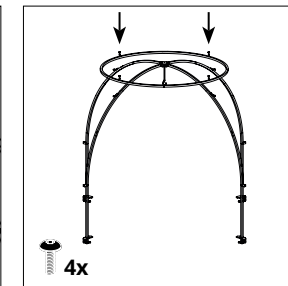
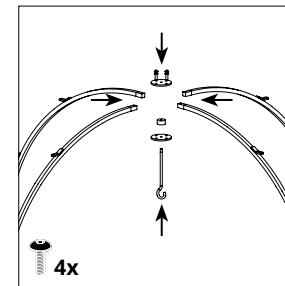
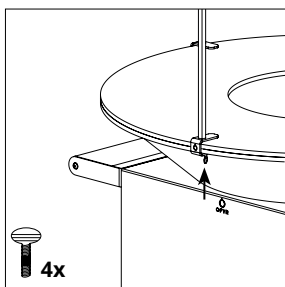
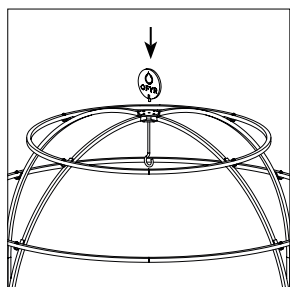
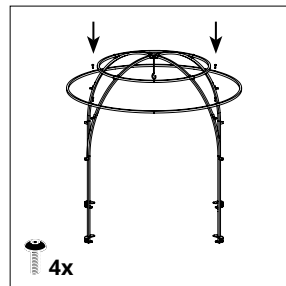
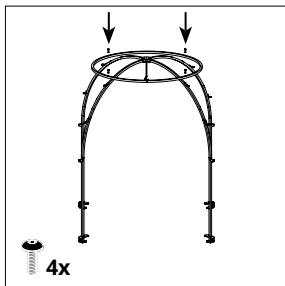
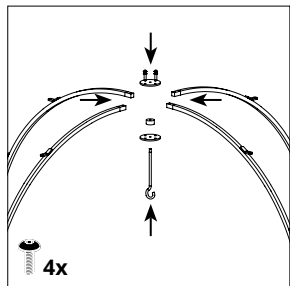
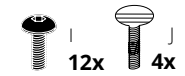

For further information, please contact one of our official distributors or dealers.
www.ofyr.com/store-locator

COPYRIGHT OFYR.

All rights reserved.

OFYR GLOBAL B.V.

Gewenten 43A
4704 RE Roosendaal
Nederland

+31 (0)165 74 31 10
info@ofyr.com
www.ofyr.com



The design of some OFYR products have EU registration under no 02580431-0001/2, no 003122373-0001 and no 007454590-0001. US Design Patents are registered under no US D798099 S and no US D830095 S.



JAN 2023 - V01

